

Establishment of Regional Fiber Optic Network for *the Central Asian Countries (*Kazakhstan, Kyrgyzstan, Tajikistan, Turkmenistan, and Uzbekistan)

Mamoru Hirayama
Japan Telecommunications Engineering and
Consulting Service (JTEC)
(Nov.10, 2010)

Contents of Presentation

1. Background
2. ICT Status of the Central Asian Countries
3. Regional Fiber Optic Network
4. Regional Network Project in Other Area
5. How to establish a Regional Fiber Optic Network for the Central Asian Countries
6. Conclusion

1. Background

Vitalization of region-wide distribution for the Central Asian Countries is considered by OSCE.

Optimization of border customs clearance using ICT is recognized as an effective way for it.

ICT: Information and Communication Technology

Needs for Region-wide social and economic activities using ICT are increasing.
(ex. e-Gov., e-learning, tele-medicine, e-commerce, etc.)

Region-wide activities require Region-wide connectivity.

Establishment of Regional Fiber Optic Network for the Central Asian Countries should be considered.

2. ICT Status of the Central Asian Countries

Broadband Service Subs. per 100 people
Current Telecommunications Network of all of the countries might be not ready for broadband service.

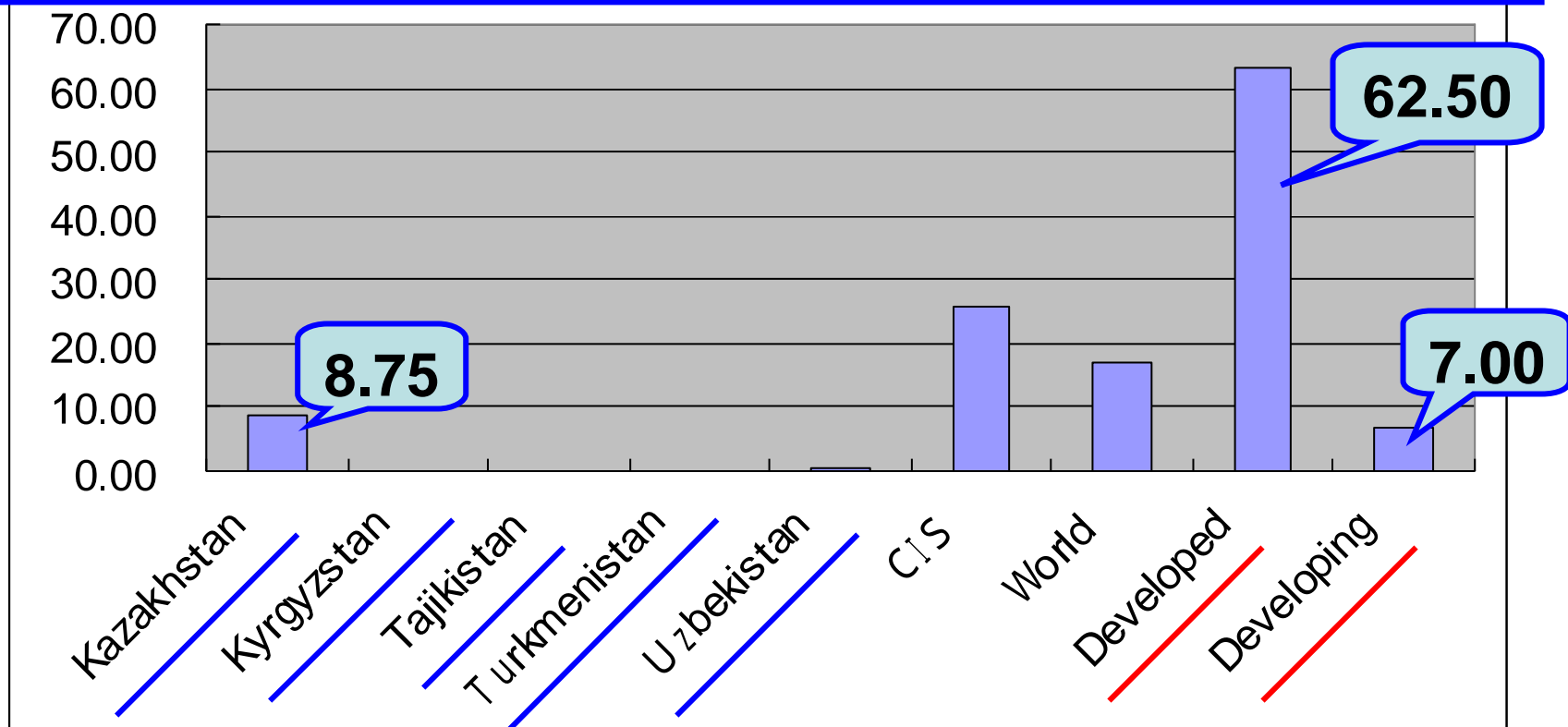

Source: ITU Telecommunication Union 2010 (Broadband Service \geq 256kps)

3. Regional Fiber Optic Network

3.1 Road and Telecommunications Networks

Road Network

[Start/End point,
Cross point,
Road]

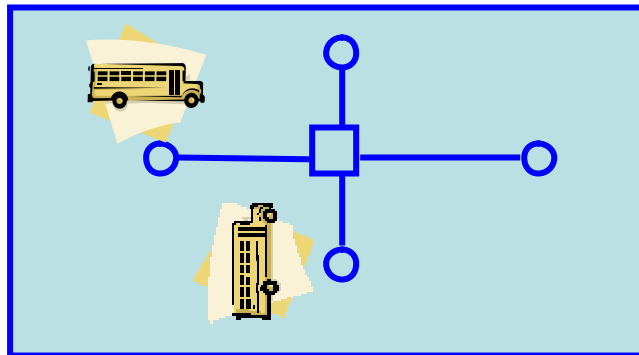

Telecommunications Network

[Terminal equipment,
Switching equipment /Router,
Transmission Media]

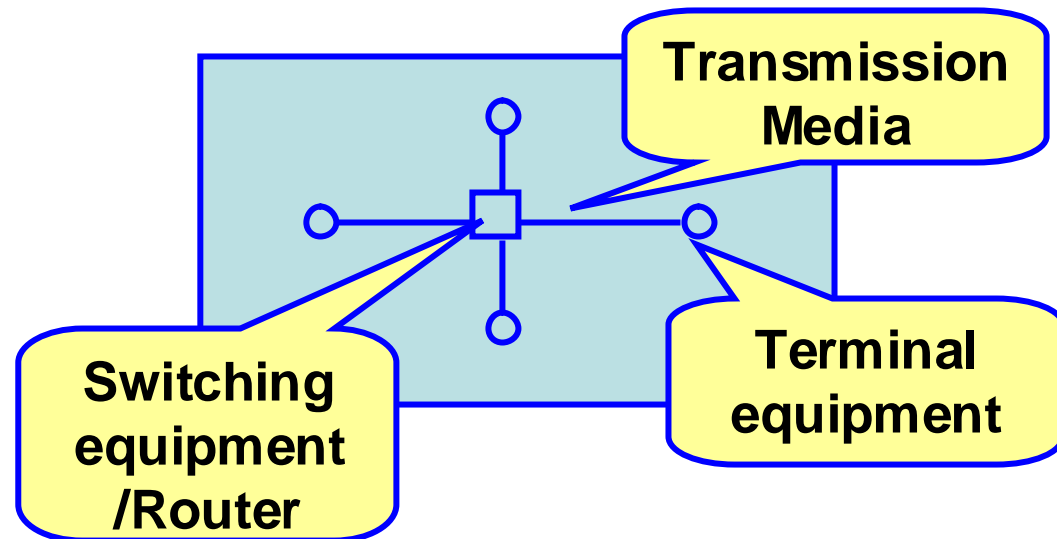

3. Regional Fiber Optic Network

3.2 Telecommunications Network Structure

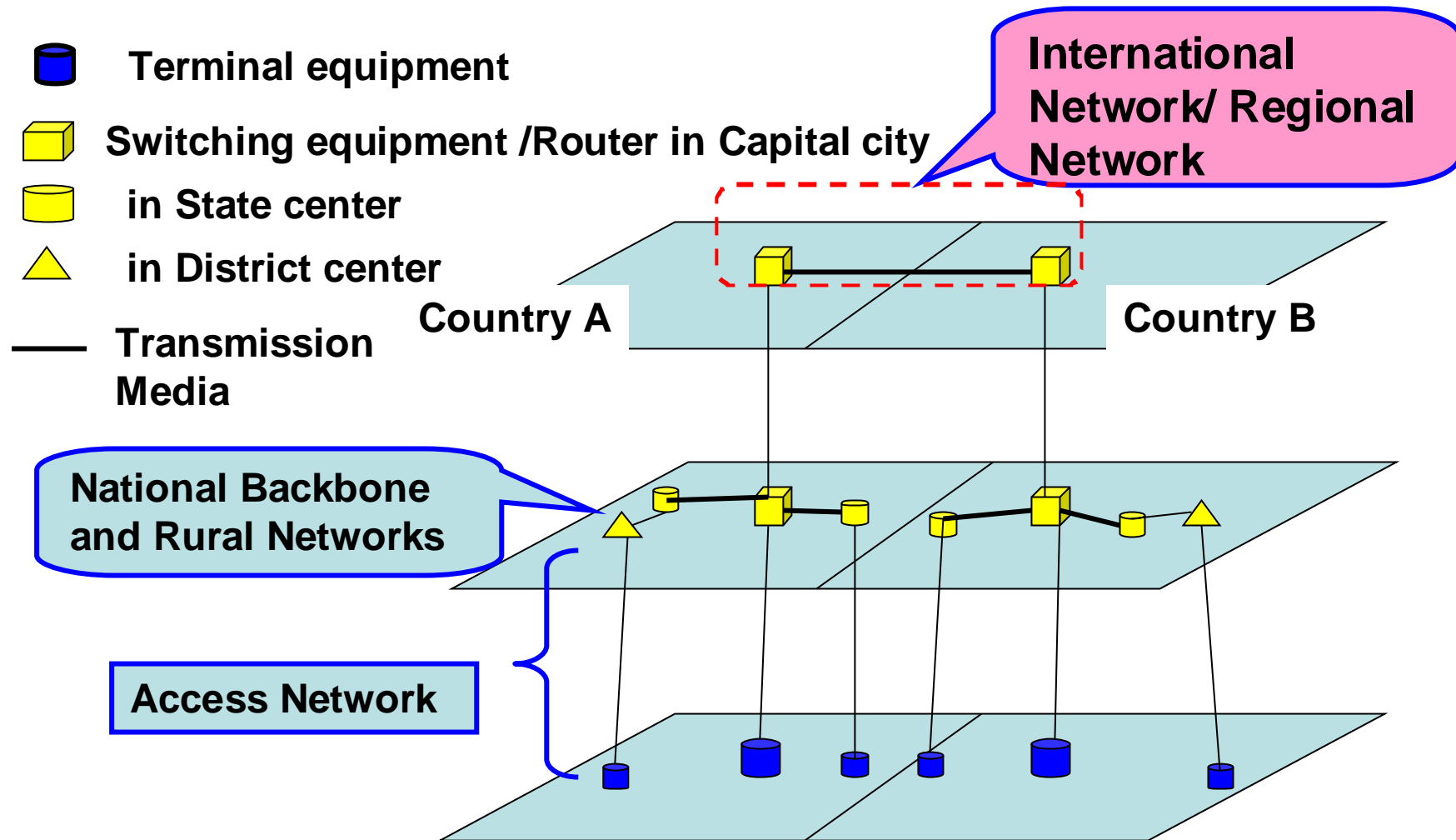

3. Regional Fiber Optic Network

3.3 Transmission Media

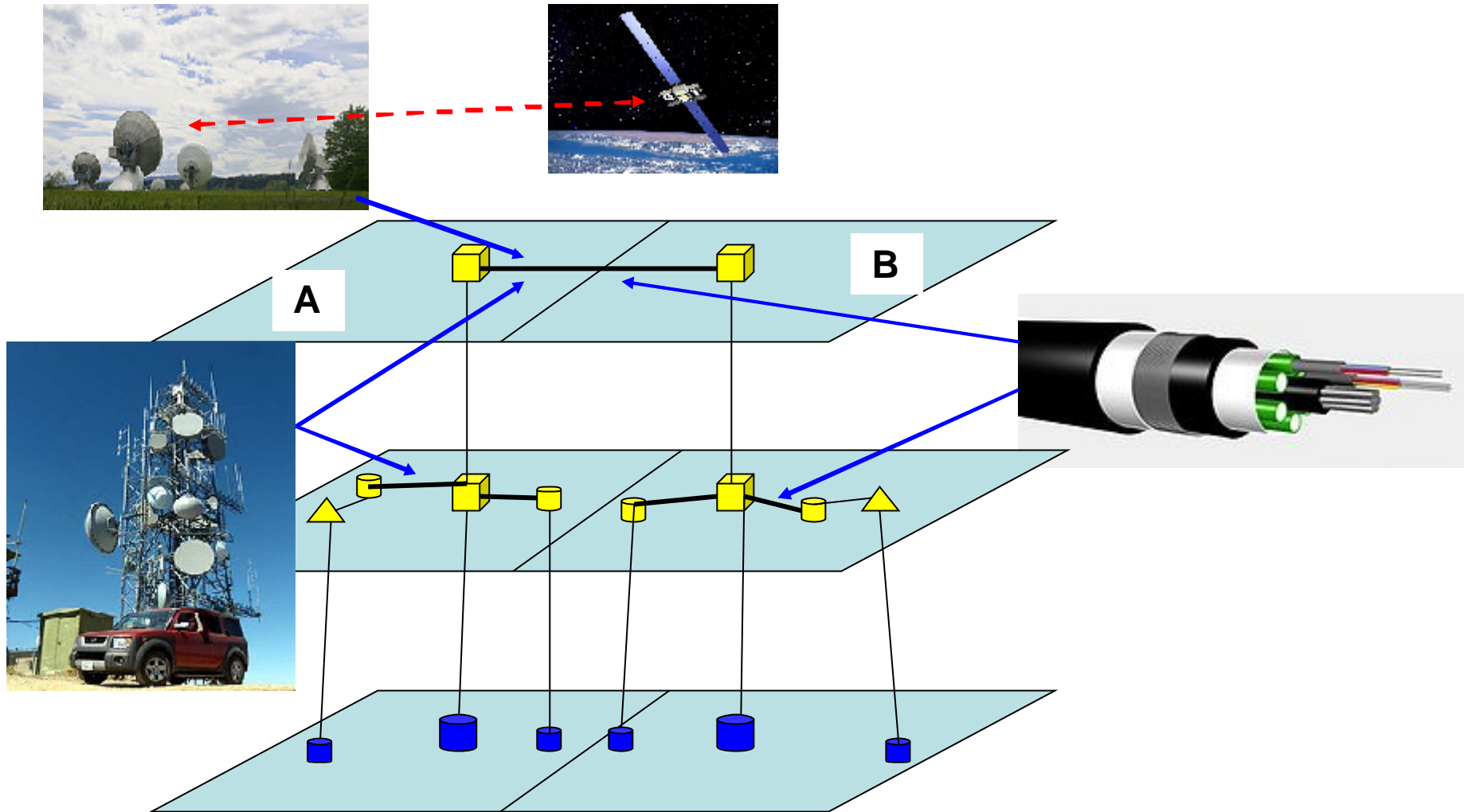

3. Regional Fiber Optic Network

3.4 Regional Fiber Optic Network

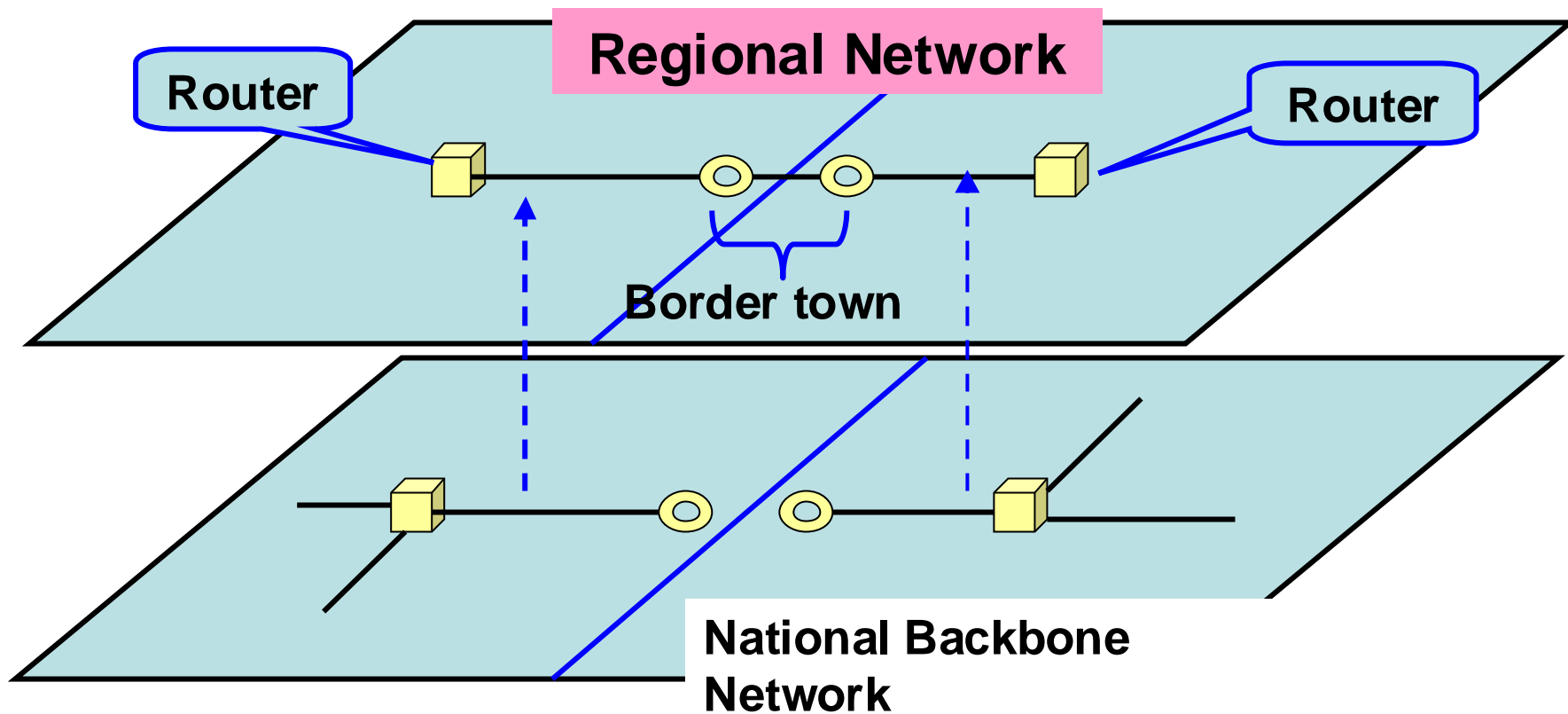

4. Regional Network Project in Other Area

4.1 SASEC Information Highway Project

SASEC: the South Asia Subregional Economic Cooperation



(Bangladesh, Bhutan, India and Nepal)

Objectives:

- To improve ICT connectivity between the SASEC countries.**
- To provide modern, affordable and reliable broadband Information, communication, and knowledge services within and across their borders to businesses.**

Source: ADB

Continue to the next slide

Cont.

Scope:

Connecting four SASEC countries with fiber optic cable.

The existing fiber optic network owned by network operators in each country to be interconnected.

A new fiber-optic backbone to be built in Bangladesh, Bhutan and Nepal, and three gateway core Routers and other equipment are installed.

Project budget:

17million USD (Funded by ADB)

4.1 SASEC Information Highway Project

Current status of their Networks

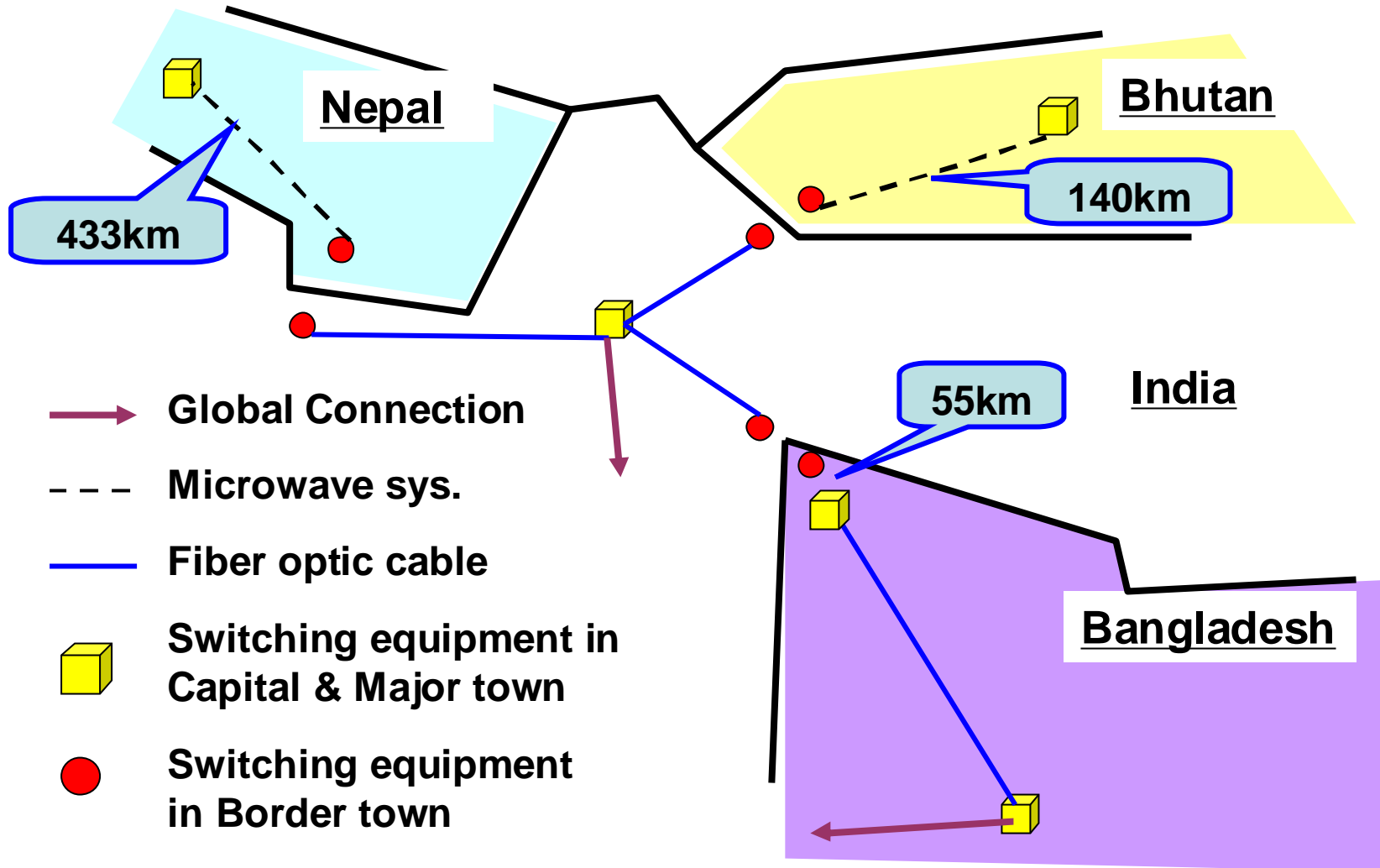

4.1 SASEC Information Highway Project

SASEC Information Highway Project

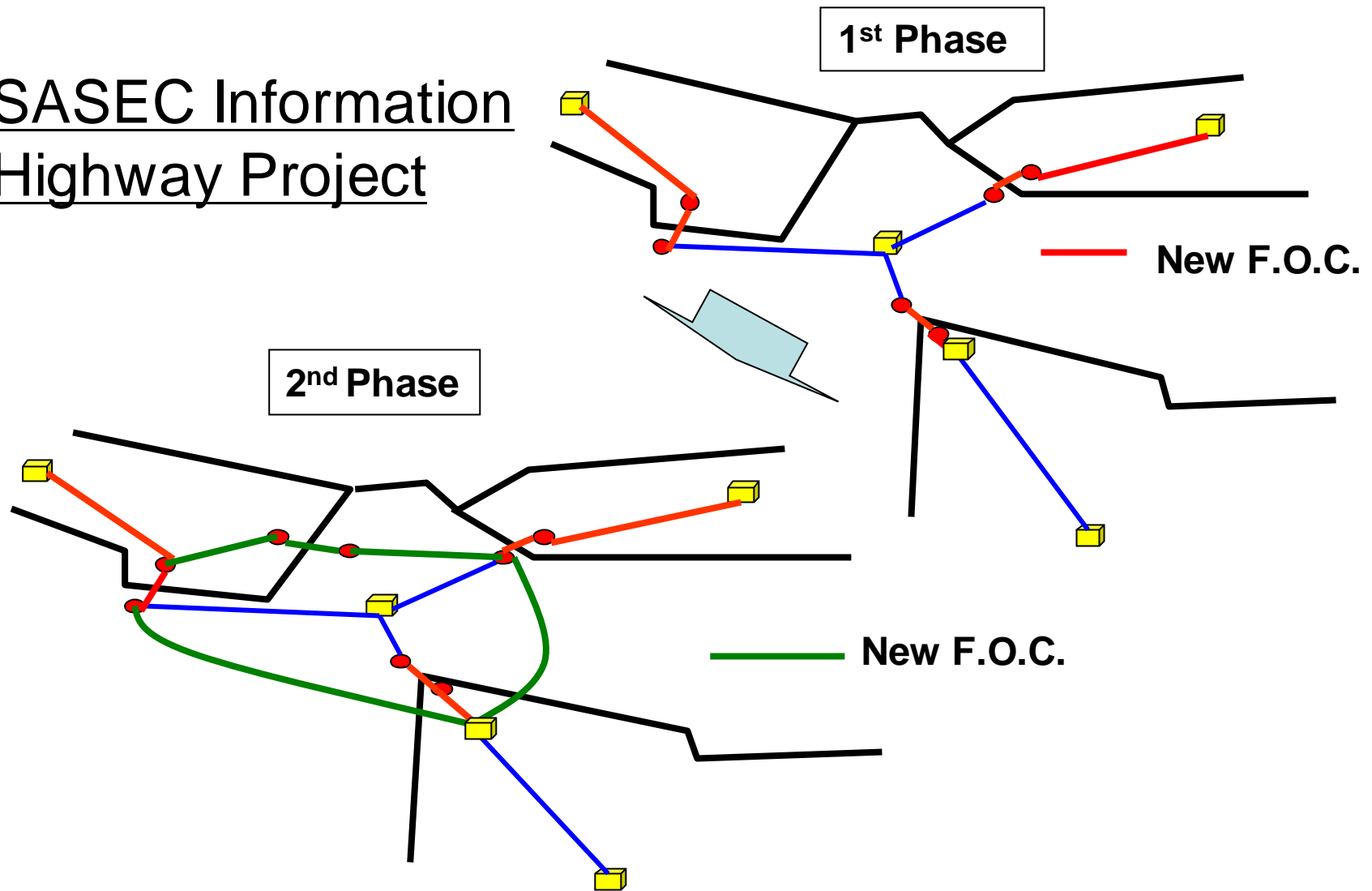

Cont.

Usage:

Regional base data exchange (include. e-Gov., e-learning, tele-medicine, e-remittance, e-commerce, etc.)

Expected Outputs:

Reducing cost of Network access, increasing the reliability of Network and providing efficient access to submarine cables for Bhutan and Nepal

Source: ADB

4.1 SASEC Information Highway Project

Operation Model

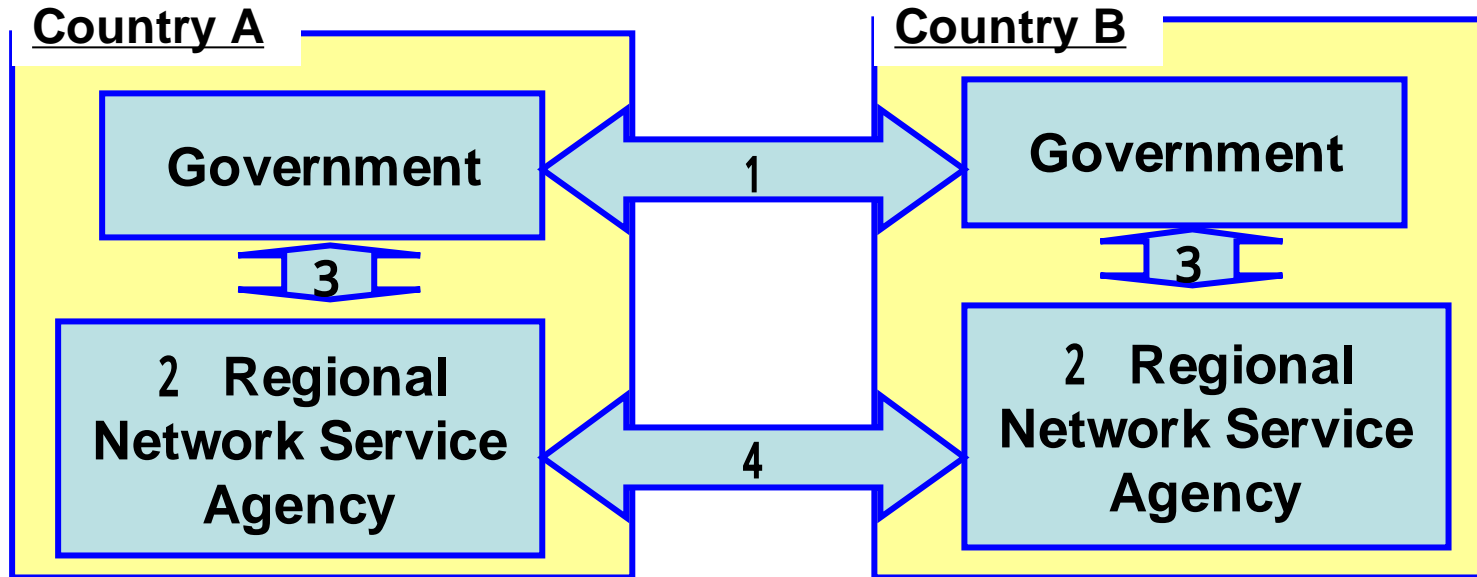

- 1 “Multilateral Cooperation Agreement” among all SASEC countries
- 2 Selection of Regional Network Service agency
- 3 “Regional Network Service Agency Agreement” between the Government and the selected service agency
- 4 “Bilateral Interconnection Agreements” between the service agencies of two countries

Definition (1/2)

- “**Multilateral Cooperation Agreement**” means the agreement entered into by the SASEC countries which sets out the overall framework and guidelines for the operation of the SASEC Regional Network, as revised from time to time.
- “**Regional Network Service Agency**” means the service agency that is responsible for providing services to a SASEC country under the Project for the operation of the SASEC Regional Network.

Source: ADB

Definition (2/2)

- “Regional Network Service Agency Agreement” means the service agency agreement to be entered into between a SASEC country and its relevant Regional Network Service Agency.
- “Bilateral Interconnection Agreement” means the agreement entered into between the Regional Network Service Agency of each country, which:
 - (a) set the terms and conditions for interconnection of, and exchange of digital traffic between, their respective in-country networks including technical specifications of networks and maintenance; and
 - (b) detail the mechanism for revenue and cost sharing.

Source: ADB

4.1 SASEC Information Highway Project

Milestone of the Project

Timing	Activities
2008.Q2	Effectiveness of Loan Agreement (Multilateral Cooperation Agreement signing)
2008.Q3	Recruitment of Project Management Consultant and Selection of Service Agencies
2008.Q4	Service Agency Agreement Signing
2008.Q4	Network Design and Bid Document Preparation
2009.Q2	Tendering and Selection of Contractors
2009.Q2	Bilateral Infrastructure Agreement Signing
2010.Q1	Installation and Testing of Networks
	Operation of Networks

5. How to establish a Regional Fiber Optic Network for the Central Asian Countries

5.1 A Regional Fiber Optic Network for the Central Asian Countries

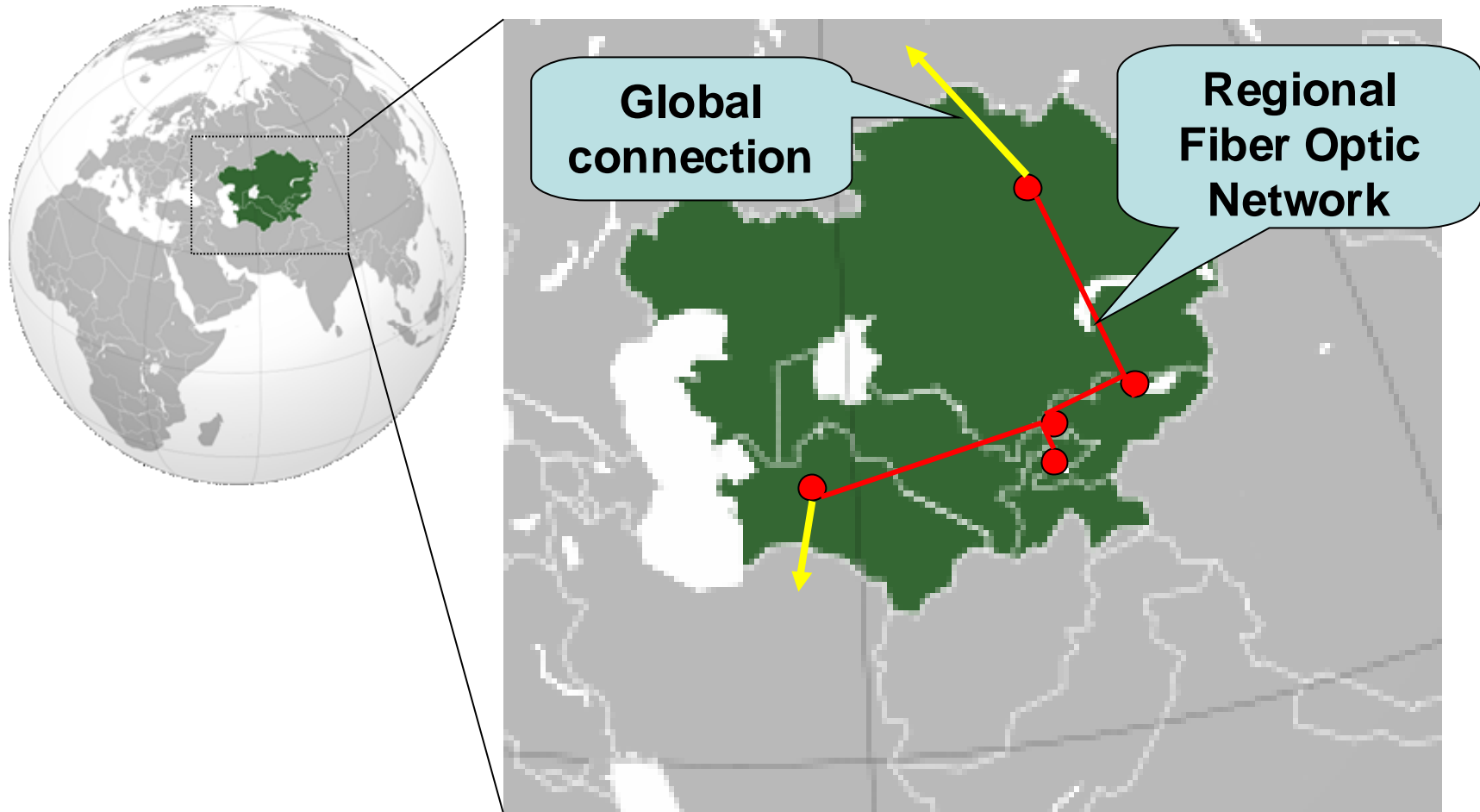

5. How to establish a Regional Fiber Optic Network for the Central Asian Countries

5.2 Outline of the Project

Objectives:

- To improve ICT connectivity between the Central Asian Countries.
- To provide modern, affordable and reliable broadband Information, communication, and knowledge services within and across their borders to government and business users.

Continue to the next slide

Cont.

Scope:

Connecting five Central Asian Countries with fiber optic cable.

The existing broadband network owned by network operators in each country to be interconnected.

A new fiber optic backbone to be built for any route sections where no fiber optic cable is available.

Project budget

≈ Total distance of new fiber optic cable in km X
20,000-30,000USD/km

Cont.

Usage:

Regional base data exchange (include. customs clearance, security, e-Gov., e-learning, tele-medicine, e-remittance, e-commerce, etc.)

Operation Model:

Multilateral cooperation agreement among all
Central Asian Countries

Selection of the Service agency

Service agency agreement

Bilateral interconnection agreement

5.3 Milestone of the Project (1/2)

Preparation stage: 18-24months

Establishment of Project Executing Agency,
Financing for the studies,

Preparing ICT Development Master Plan,

Implementing various studies (Technical
Feasibility Study (FS), Financial and Economic
FS, Environmental study, and Legal study),

Financing for the project

5.3 Milestone of the Project (2/2)

Implementation stage:24-36months

S+0: Multilateral Cooperation Agreement
Signing

S+3: Selection of service Agencies

S+6: Service Agency Agreement Signing

S+6: Network Design and Bid Document
Preparation

S+12: Tendering and Selection of Contractors

S+12: Bilateral Infrastructure Agreement Signing

S+24-36: Installation and Testing of Network
Operation of the Network

6. Conclusion

Purpose:

To provide the information on Establishment of Regional Fiber Optic Network for the Central Asian Countries.

Information on the Regional Fiber Optic Network was provided to understand the network, a Regional Fiber Optic Project was provided to understand the project, and how to establish a Regional Fiber Optic Network for the Central Asian Countries was provided for its consideration.

About JTEC

- Japan Telecommunications Engineering and Consulting Service (JTEC)
 - President:
Mr. Yoshio Utsumi
(former Secretary-General of ITU)
 - Over the past 30 years, JTEC has been providing its services such as feasibility studies for planning and enhancement of Telecommunication networks and Broadcast systems to a number of organizations and Governments over 80 countries around the world. And more
- URL: <http://www.jtec.or.jp>

Thank you for your attention.

